

# PASTORES ELECTRICOS ELECTRIC FENCING



2018



GARANTIA 3 AÑOS

**Ranger N80**  
Ranger N80



Cod. 91500  
Input: 6J



GARANTIA 2 AÑOS

**Equistop M3 VCS**  
Equistop M3 VCS



Cod. 91501  
Input: 3J



230V	12V	INPUT	max. OUTPUT	max. ⚡	500 Ω	max. ⚡	🔋	📏	📏	📏	📏	📏	+
✓	-	6J	4,2J	10.500 V	5.600 V	10.000 V	7 W	100 km	40 km	10 km	4 km	4 x 1,5 m	

230V	12V	INPUT	max. OUTPUT	max. ⚡	500 Ω	max. ⚡	🔋	📏	📏	📏	📏	📏	+
✓	-	3J	2,3J	13.000 V	5.200 V	4,5 W	60 km	20 km	6 km	2 km	2 x 1,5 m		

**Scout N2 pigeons**  
230V Scout N2 colombes



Cod. 91505



GARANTIA 3 AÑOS



GARANTIA 3 AÑOS



**Educ Control**  
Educ Control



Cod. 91503  
Pastor 230V Educ Control



GARANTIA 2 AÑOS

**Hobbygard N**  
230V Hobbygard N



Cod. 91502  
Input: 0,25J



**Kit Hobbygard N**  
Kit Hobbygard N



Cod. 91504  
Input: 0,25J



230V	12V	INPUT	max. OUTPUT	max. ⚡	500 Ω	max. ⚡	🔋	📏	📏	📏	+
✓	-	0,25J	0,15J	6.500 V	1.000 V	2 W	3 km	1,5 km	0,5 km	1	

230V	12V	INPUT	max. OUTPUT	max. ⚡	500 Ω	max. ⚡	🔋	📏	📏	📏	+
✓	-	0,25J	0,15J	6.500 V	1.000 V	2 W	3 km	1,5 km	0,5 km	1	



**Solar Farmer AN1000**  
Solaire Farmer AN1000



**Cod. 91506**  
Input: 1,4J

(Battery not included)

**230V Farmer AN15**  
230V Farmer AN15



**Cod. 91507**  
Input: 1,3J

(Battery not included)

**230V Trapper AN12**  
230V Trapper AN12



**Cod. 91512**  
Input: 1,2J

(Battery not included)

**EquiStop B1 (9V / 12V)**  
EquiStop B1 (9V / 12V)



**Cod. 91510**  
Input: 0,18J

(Battery not included)

	230V	12V	INPUT	max. OUTPUT	max. ⚡	500 Ω ⚡	🔋	CEE	max.	max.	+
AN 1000	✓	✓	1,4J	1,0J	11.000V	4.800V	90mA	10km	3,5km	1,2km	1
AN 15	✓	✓	1,3J	1,0J	11.500 V	4.200 V	30-90 mA	8 km	3,5 km	1,2 km	1 x 1 m

	230V	12V	INPUT	max. OUTPUT	max. ⚡	500 Ω ⚡	🔋	CEE	max.	max.	+
AN 12	✓	✓	1,2J	0,8 J	8.400 V	3.600 V	90 mA	8 km	3,5 km	1,2 km	2 x 1 m
B1	-	✓	0,18 J	0,12 J	8.600 V	1.500 V	15mA	3 km	1 km	0,3 km	1 x 1 m

**SOLAR 230V Trapper AS35**  
Solaire 230V Trapper AS35



**Cod. 91509**  
Input: 1,2J

(Battery not included)

**Kit poultry 12/230 V energizer**  
Électrificateur 12/230 V kit volaille



**Cod. 91508**  
Input: 0,33J

(Battery included)

	230V	12V	INPUT	max. OUTPUT	max. ⚡	500 Ω ⚡	🔋	CEE	max.	max.	+
AS 35	✓	✓	0,33 J	0,24 J	9.000 V	3.100 V	26 mA	5 km	3,6 km	0,9 km	1 x 1 m
KIT ENERGIZER	✓	✓	1,2 J	0,8 J	8.400 V	3.600 V	90 mA	8 km	3,5 km	1,2 km	2 x 1 m



**6V Kit HobbyGard B**  
6V Kit HobbyGard B

**Cod. 91511**  
Input: 0,5J

(Battery not included)

	230V	12V	INPUT	max. OUTPUT	max. ⚡	500 Ω ⚡	🔋	CEE	max.	max.	+
	-	6 V	0,5J	0,15 J	6.500 V	1.000 V	12 mA	3 km	1,5 km	0,5 km	1 x 1 m

**Anti-Bark collar**  
Collier Anti-Aboiement



**Cod. 91516**



**2W SOLAR KIT**  
2W Kit Solaire



Cod. 91520  
Energizer not included



**Fence TESTER PLUS**  
Testeur de clôture Tester Plus



Cod. 91521



**Fence tester ISOTESTER 10000**  
Testeur de clôture Isotester 10000

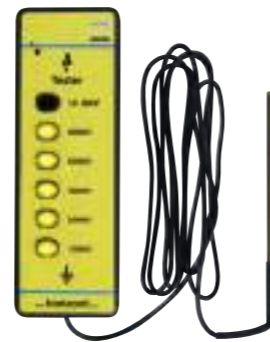

Cod. 91522



**Electric connector for cord**  
Connecteur électrique pour cordon



Cod. 91539



**Splicing tape 10/20 (x10)**  
Épissage bande 10/20 (x10)



Cod. 91540



**Splicing tape 40 (x5)**  
Épissage bande 40 (x5)

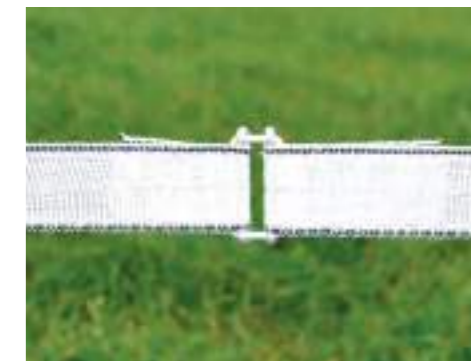

Cod. 91541



**Fence switch**  
Interrupteur de clôture



Cod. 91523



**Notice signal two sides (x4)**  
Signal pour remarquer deux côtés (x4)



Cod. 91524



**Lightning protection**  
Protection contre la foudre

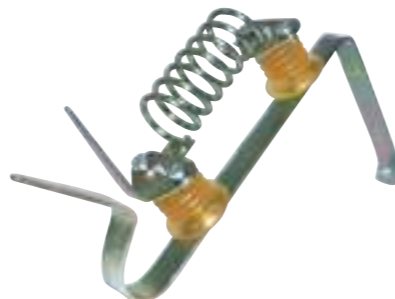

Cod. 91525



**Splicing cord (x10)**  
Épissage cordon (x10)



Cod. 91542



**Splicing thread (x5)**  
Épissage fil (x5)

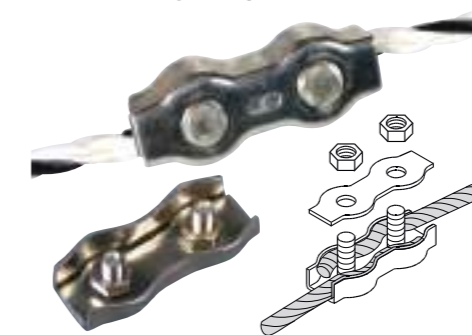

Cod. 91543



**Tensor cord/thread (x2)**  
Tendeur fil/cordon (x2)



Cod. 91544



**Grounding pike 1m**  
Pique prise de terre 1m

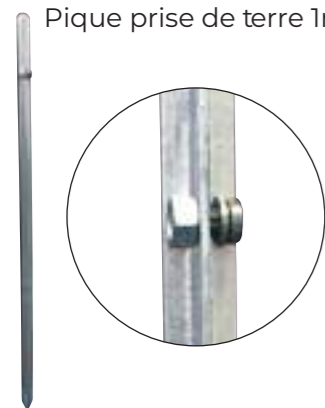

Cod. 91526



**Connection kit for fences**  
Kit de connexion pour les clôtures



Cod. 91537



**Electric connector for tape**  
Connecteur électrique pour bande



Cod. 91538



**Grounding pike connection wire (10m)**  
Câble de connexion pique prise de terre



Cod. 91545



**Grounding pike connection wire (25m)**  
Câble de connexion pique prise de terre



Cod. 91546



**Connection wire between lines (x2)**  
Câble de connexion entre les lignes (x2)

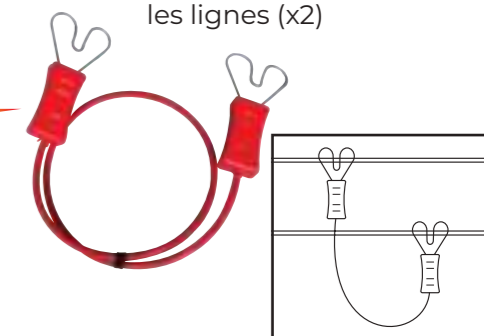

Cod. 91547



**Tape TURBOMAX (200m)**  
Bande TURBOMAX (200m)



T12  
Cod. 91530

T20  
Cod. 91531

T40  
Cod. 91532

**Tape FARMER (200m)**  
Bande FARMER (200m)



T 10  
Cod. 91527

T 20  
Cod. 91528

T 40  
Cod. 91529

**Thread FARMER W6 (250m)**  
Fil FARMER W6 (250m)



Cod. 91533

**Thread TURBOMAX W6 (200m)**  
Fil TURBOMAX W6 (200m)



Cod. 91534

**Cord FARMER R6 (200m)**  
Cordon FARMER R6 (200m)



Cod. 91535

**Cord TURBOMAX R6 (200m)**  
Cordon TURBOMAX R6 (200m)



Cod. 91536

**Electric mesh for rabbits 0,50x50m**  
Filet électrique pour lapins 0,50x50m

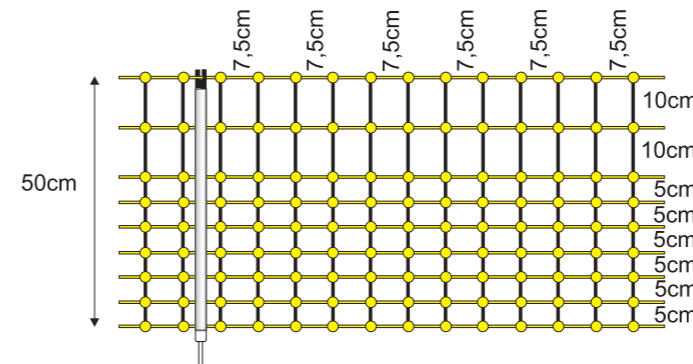

Cod. 91567

**Electric mesh for birds 1,05x50m**  
Filet électrique pour volaille 1,05x50m

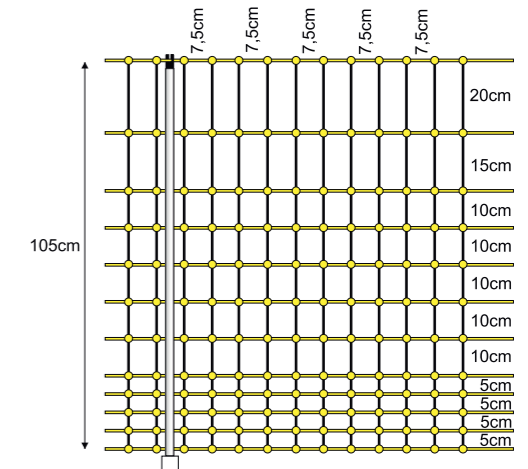

Cod. 91568

**Electric mesh for sheep 0,90x50m**  
Filet électrique pour moutons 0,90x50m

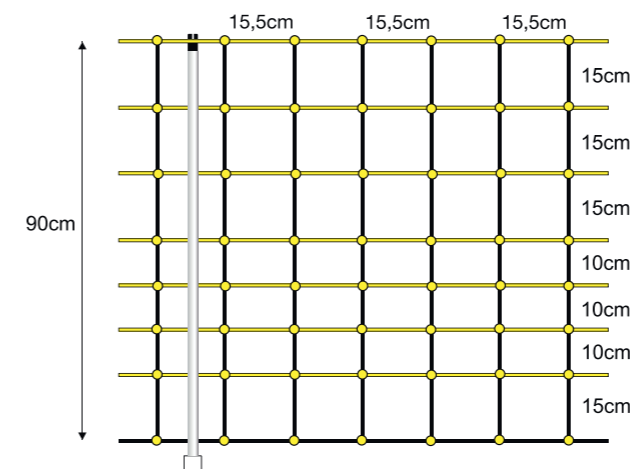

Cod. 91569

**Electric mesh for goats 1,05x50m**  
Filet électrique pour chèvres 1,05x50m

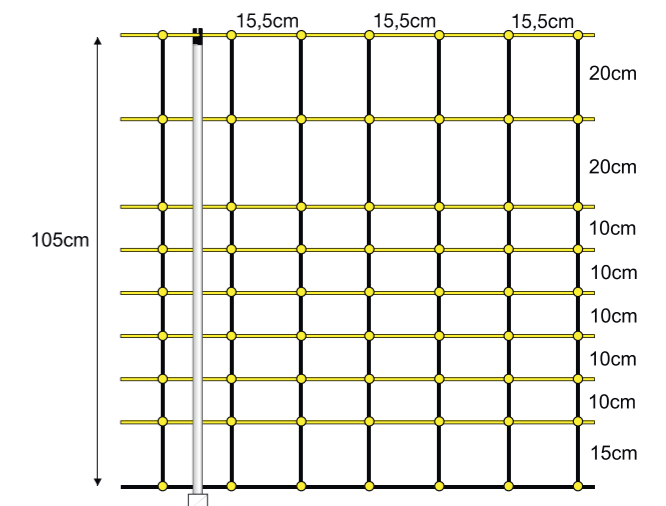

Cod. 91570



**Isolating handle (x100)**

Poignée pour isoler (x100)



Cod. 91548



**Farmer (x25) / Ranger (x25)**

Isolateur Farmer / Ranger (x25)



Cod. 91549  
Farmer IS-S ø5



Cod. 91550  
Ranger IS-S ø6



**Cord insulator IP-15 (x10)**

Isolateur pour cordon IP-15 (x10)

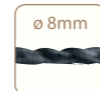

Cod. 91551



**Install-isolator adapter**

Installez-isolateurs adaptateur

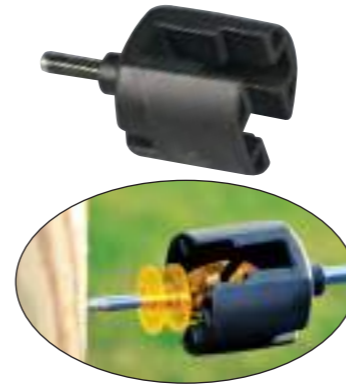

Cod. 91558



**Grip Farmer G**

Poignée FARMER G



Cod. 91559



**Cord grip kit 6mm**

Kit poignée cordon 6mm



Cod. 91560



**Insulator for tape (x25)**

Isolateur pour bande (x25)

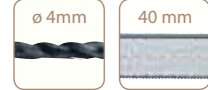

Cod. 91552



**Insulator for metric thread M6x30 (x25)**

Isolateur pour fil metrique M6x30 (x25)



Cod. 91553



**Economy cord insulator (x25)**

Cordon insulateur Economy (x25)

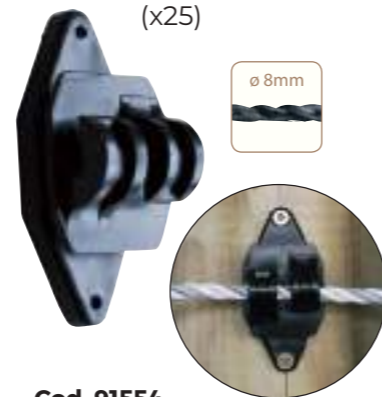

Cod. 91554



**Cord grip kit 40mm**

Kit poignée cordon 40mm



Cod. 91561



**Grip kit with spring**

Kit poignée avec ressort



Cod. 91562



**Door insulator 6mm (x10)**

Isolateur porte 6mm (x10)



Cod. 91563



**Ranger I-40 FIX (x12)**

Ranger I-40 FIX (x12)



Cod. 91555



**Ranger IDS ø6x200 (x10)**

Ranger IDS ø6x200 (x10)

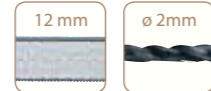

Cod. 91556



**Farmer PND (x50)**

Farmer PND (x50)



Cod. 91557



**Door insulator M6x30 (x5)**

Isolateur porte M6x30 (x5)



Cod. 91564



**Door insulator 3 lines (x2)**

Isolateur porte 3 lignes (x2)



Cod. 91565



**Roller Super Roller 500**

Enrouleur Super Roller 500



Cod. 91566





2018  
COPELE



### Alcaline battery 9V

Batterie alcaline 9V

cm: 16,5 x 11 x 11,5 h.

55 Ah  
Cod. 91579



Cod. 91581  
170 Ah

cm: 19 x 12,5 x 16 h.

120 Ah  
Cod. 91580



### Rechargeable battery 12V

Batterie rechargeable 12V



Cod. 91576  
7 Ah

cm: 15 x 6,5 x 9,5 h.



Cod. 91578  
18 Ah

cm: 18 x 7,7 x 16 h.



Cod. 91577  
12 Ah

cm: 15 x 9,8 x 9,5 h.



Cod. 91582  
Charger 12v.



### Post

Poteau

Fiberglass post 10 x 115

25 Ud.

Cod. 91574



Fiberglass post 10 x 115

25 Ud.

Cod. 91575



Plastic post 10 x 115

10 Ud.

Cod. 91571



Plastic post 10 x 115

10 Ud.

Cod. 91572



Plastic post 10 x 115

10 Ud.

Cod. 91573

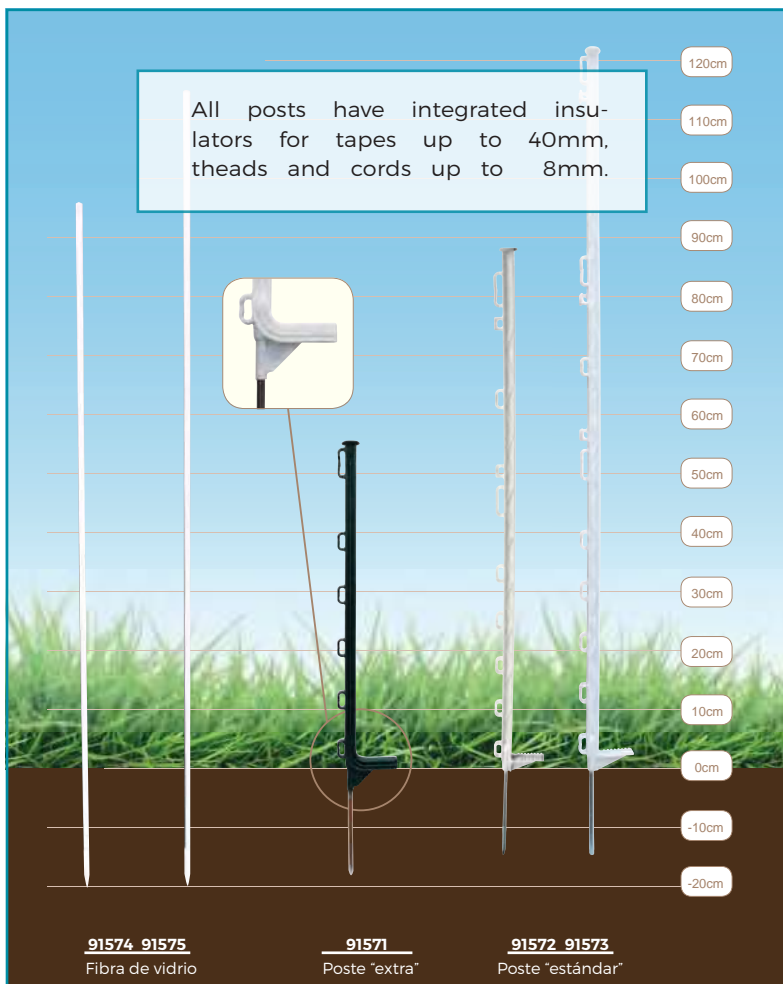

COPELE reserves the right to modify its products in relation to the features and specifications listed in this catalogue if there is a possibility of improving them. COPELE ante la posibilidad de mejorar sus fabricados, se reserva el derecho a modificarlos y especificaciones presentes en este catálogo.